

# MOX500 Series

## Epoxy Molded, Metal Glaze-Metal Oxide Resistors



### FEATURES

- Meets Mil-Std-202
- Meets IEC 61000-4-5 up to 2KV
- Molded Construction
- Available in E96 values

### CHARACTERISTICS

<b>Resistor Type</b>	Thick Film, Epoxy Molded
<b>Power Rating</b>	2W at 70°C 3W at 25°C
<b>Resistance Range</b>	Metal Glaze: 2%, 5% 1.5KΩ–5MΩ 100/200 ppm
<b>Tolerance</b>	Metal Oxide: 1%, 2%, 5% 15Ω – 1.4KΩ 350 ppm
<b>Temp. Coeff. Resistance</b>	Not all tolerances and TCR values available throughout entire resistance range
<b>Construction</b>	Metal glaze 100/200 ppm Metal oxide 350 ppm
<b>Max. Working Voltage</b>	RCWV or 1000 V whichever lesser. (RCWV = rated DC or RMS AC continuous working voltage at commercial line frequency and waveform (volt) )
<b>Diel. Withstanding Volt.</b>	1000 VRMS
<b>Terminals</b>	Copper Wire, Solder Coated axial, RoHS composition
<b>Oper. Temp.</b>	-55° to +155°C

Characteristic	Test Method	ΔR limits
<b>Moisture Resistance</b>	MIL-STD-202, Method 106G	±0.20%
<b>Humidity</b>	MIL-STD-202, Method 103, Condition B	±0.25%
<b>Shock</b>	MIL-STD-202, Method 213, Condition I	±0.10%
<b>Vibration</b>	MIL-STD-202, Method 204, Condition D	±0.10%
<b>Terminal Strength</b>	MIL-STD-202, Method 211A, Condition A or B	±0.10%
<b>Short Term Overload</b>	DC test potential 2.5 time the rated continuous working voltage but not exceeding twice the maximum voltage specified	±0.5%
<b>Load Life</b>	1000 hrs at RCWV duty cycle 1.5hr ON, 0.5 hr OFF at 70°C ±2°C	±2%
<b>Temperature Cycling</b>	-65° to +125°C	±0.10%
<b>Resistance to soldering heat</b>	Temp 350°C ±10°C for 3 ±0.5 sec	±1%
<b>Surge Immunity</b>	IEC61000-4-5, waveform 1.2/50μS, 10 Pulses applied. Does not include values under 1KΩ.	<±1%

### Derating

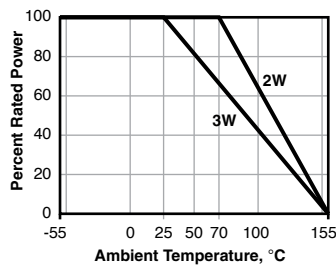

### Single Impulse Test

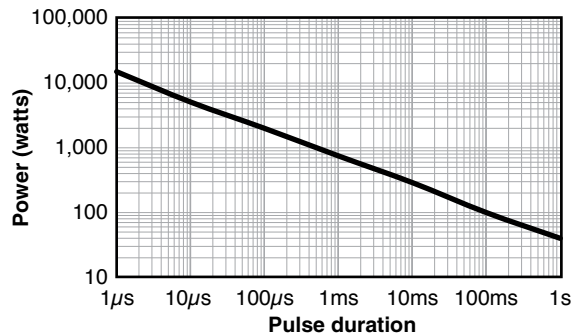

### Surge Immunity Test

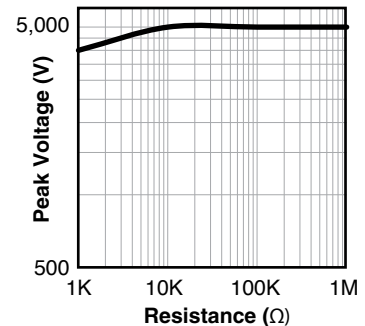

### DIMENSIONS

in./mm

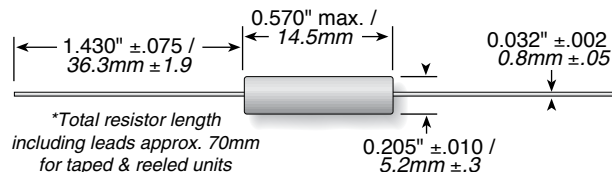

# MOX500 Series

## Epoxy Molded, Metal Glaze-Metal Oxide Resistors

### TAPE & REEL

EIA-296 standard

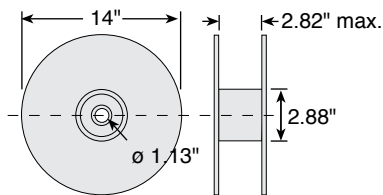
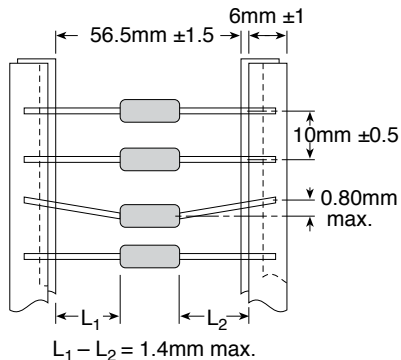

### ORDERING INFORMATION

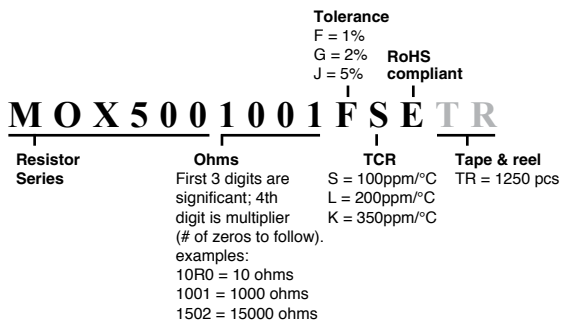

### Standard part numbers for MOX500 Series

Resistance	2% tolerance	5% tolerance
100		MOX500100RJSE
150		MOX500150RJSE
270		MOX500270RJSE
1K		MOX5001001JSE
1.5K		MOX5001501JSE
2.7K	MOX5002701GSE	
3.3K		MOX5003301JSE
4.3K		MOX5004301JSE
6.8K		MOX5006801JSE
7.5K	MOX5007501GSE	
10K		MOX5001002JSE
15K		MOX5001502JSE
18K		MOX5001802JSE
20K	MOX5002002GSE	
27K	MOX5002702GSE	
33K		MOX5003302JSE
47K	MOX5004702GSE	
66K		MOX5006602JSE
100K	MOX5001003GSE	
150K	MOX5001503GSE	
220K	MOX5002203GSE	
270K	MOX5002703GSE	
330K	MOX5003303GSE	
1M	MOX5001004GSE	